

Satlook Micro G2 / HD User Manual

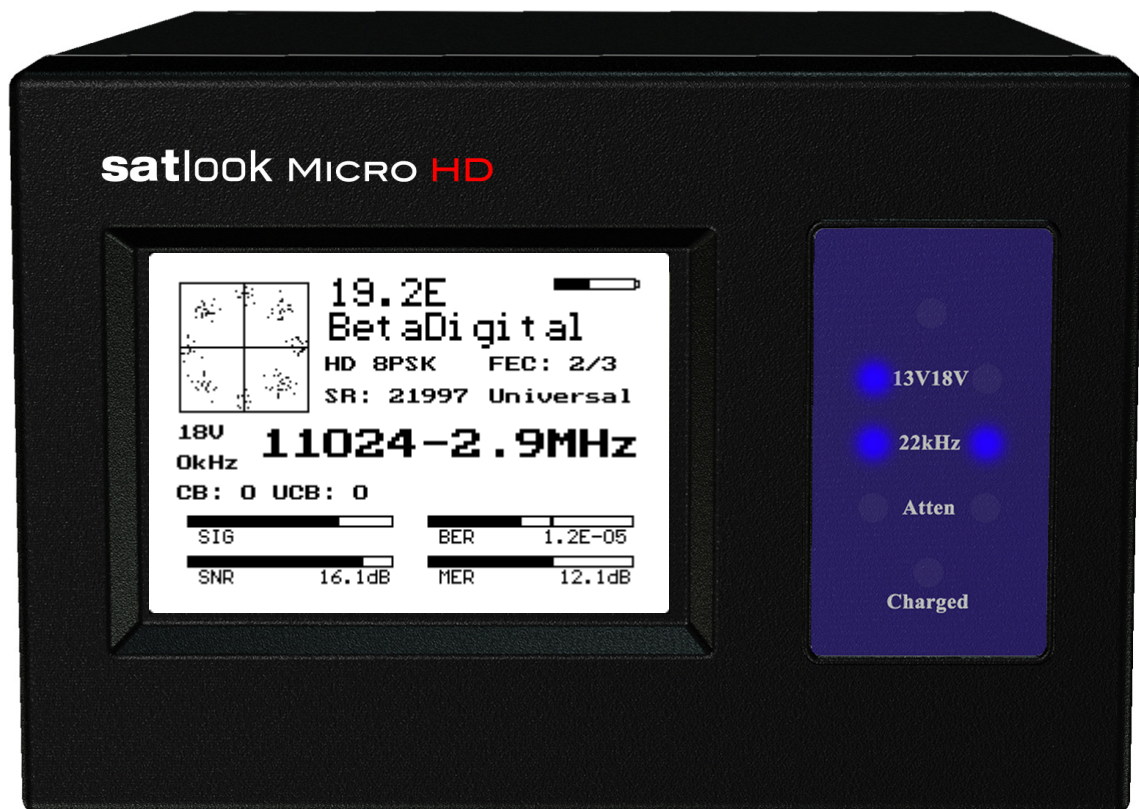

Contents

Overview	<i>page 3</i>
Quick Start	<i>page 4</i>
EasyFind Mode	<i>page 6</i>
Digital Mode	<i>page 7</i>
Spectrum Mode	<i>page 13</i>
Analog Mode	<i>page 15</i>
Setup Functions	<i>page 19</i>
Loading New Firmware	<i>page 24</i>
Using PC to Transfer Transponder Data	<i>page 25</i>
Appendix A - Saved Parameters	<i>page 26</i>
Appendix B - Universal LNB Primer	<i>page 27</i>
Appendix C - DiSEqC Primer	<i>page 28</i>
Appendix D - DVB-S and DVB-S2 Primer	<i>page 30</i>
Appendix E – UniCable Primer	<i>page 31</i>
Appendix F - Satlook G2 and HD *.smd File Structure	<i>page 33</i>
Appendix G - Satlook G2 Specifications	<i>page 34</i>
Appendix H - Satlook HD Specifications	<i>page 35</i>
Glossary	<i>page 36</i>
French Satlook G2/HD Manual	<i>page 39</i>

This manual is applicable for the Satlook G2 with firmware level above smG2HD-106.
For earlier firmware revisions, use the Satlook G2 User manual

(updated July 22, 2010)

Overview

The Satlook G2 and Satlook HD are Satellite Test Equipment for the professional made in Sweden. The Satlook G2 can receive DVB-S satellite signals and the Satlook HD can receive both DVB-S and DVB-S2 satellite signals. Both use advanced demodulators and can "lock" on transponders using automatic modulation type, symbol rate and FEC selection. They are easily operated with just three controls and the basic functions are easy to learn.

The instruments are provided with a 3" LCD which is used to display information such as signal strength, Spectrum, or Digital information.

The Satlook G2 and Satlook HD can be used to measure satellite signals from two LNBS at the same time. Signal strength is presented graphically on the LCD display in form of thermometer scales.

They can also sound a tone which increases in pitch with signal level on an internal loudspeaker.

They can store 100 positions of Satellite transponder information. The instruments can easily scan through the memory positions and identify the various Satellite transponders.

The polarisation of the LNB is switchable by setting the LNB voltage to 13V or 18V and the High Low band with a 22 kHz signal. The DiSEqC function controls all DiSEqC accessories such as LNBS, switches, and positioners.

The instruments are supplied with a built-in and rechargeable battery and a carrying case for protection of the instrument in the installation environment.

Quick Start

- Power On/Off Button
- Menu Knob and Button
- LNB-A connector
- LNB-B connector
- Power Input for charging
- RS232 Port
- Reset Button



Power On

The Satlook G2 / HD is turned on by pressing and holding the power on button for one second. Power on tones indicate that firmware loading has started. This takes about six seconds for the Satlook HD and is shown by a progress bar on the display and a pattern on the blue LEDs.

The initial mode can be set by the user for convenience. Pressing and holding the power button also turns off the instrument. The button must be held for more than one second in order to turn the unit off. The Satlook G2 / HD also has an automatic power down that is adjustable which will turn the unit off when there is no activity. This can be set using the Setup Menu.



Navigation

The Menu Button and Menu Knob are the two controls used for navigation through the menus and selection of functions. When the menu is off, pressing the Menu Button shows the Menu. It is shown at the active mode, so if the Satlook G2 / HD is in Digital mode, the menu is shown with the Digital entry at the top. Using the knob, the function that is to be executed is shown highlighted. Pressing the Menu Button causes the function to be performed. For simple functions such as switching the LNB Voltage with the 13V/18V function, the Satlook G2 / HD performs this function, turns off the menu, and immediately returns to the current mode.

For other functions, a new screen with choices is presented. Pressing the Menu Button selects the highlighted item. Some of these other functions have an exit function that is used to return to the current mode.

The Menu Knob is used for Frequency adjustment when in the Digital mode or the Spectrum mode. When the Menu Knob is turned slowly, the frequency is changed by 1MHz, but if rotated rapidly, the frequency step is increased allowing for quick movement to the correct frequency.

Charging

Before using the Satlook G2 / HD, it should be fully charged.

To charge the instrument, connect the external power supply or 12V Car Cigarette Lighter Plug and then plug the external power supply into the DC Input connector. The charging process will begin and the blue LED lights will cycle indicating charging. The charging mode and time of charging are displayed on the screen.

A full charge can take up to 14 hours, but depending on the battery state can be completed sooner. When charging is complete, the bottom LED will be lit indicating that the charging is complete. The Satlook G2 / HD can be operated using the external power supply, but when the instrument is on, no charging is being performed.

The battery state is indicated on the Analog screen by a battery symbol.

EasyFind Mode

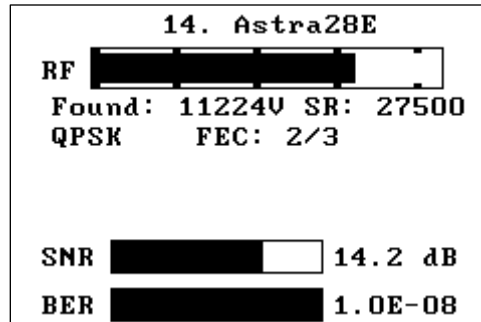
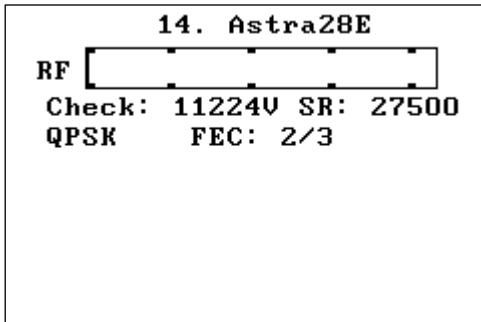

The EasyFind Mode is an easy way to point the dish at installation. When the EasyFind Mode is entered, the Profile defined in the Setup EasyFind Configuration is used. The five satellite transponders (or in the case of All Sats, all of the memory positions) which are in the Profile can be selected with the knob.

Initially the display will appear as in the left diagram above and the RF signal will be indicated on the display and by a tone with increasing frequency as the RF signal increases. Turn the knob to select one of the five transponders in the Profile. Point the dish in the approximate position, and move it slowly until the Satellite is found as in the right picture above. There is an audible indication of the correct satellite and a different audible indication if the wrong satellite is found. If the indication is correct, then the screen will show the NIT data after a few seconds for final confirmation. Now the Digital mode can be used for final peaking. EasyFind Mode is exited by pressing the button.

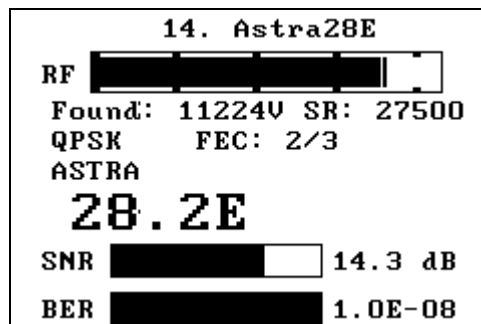

Digital Mode

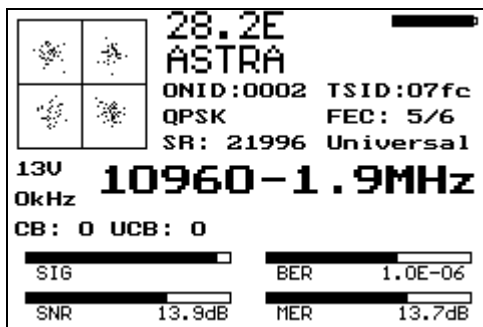

Locked

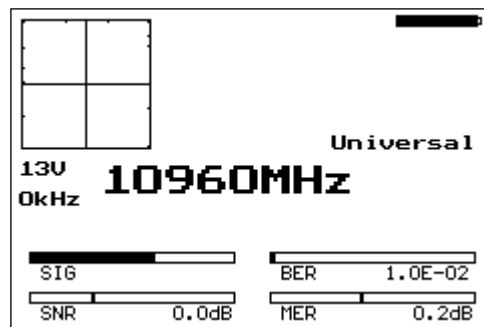

Not Locked

About Digital Mode

When the user enters Digital Mode, the Satlook G2 will attempt to receive a DVB-S signal at the current frequency and the Satlook HD will also try to receive a DVB-S2 signal. The current frequency is displayed in the centre of the screen and can be changed by the knob (within the limits of the current LNB type and the 22 kHz setting). The state of the battery is displayed in the upper right corner of the screen.

When a signal is received, the Satlook G2 / HD is "locked" and the modulation mode is displayed. This will be shown as *QPSK*, or with the Satlook HD, *QPSK HD* or *8PSK HD*. The current FEC and symbol rate are shown along with the LNB type definition being used.

If the signal is locked, then the frequency displayed includes the frequency offset to the signal centre frequency. Usually, the instruments will lock to a signal up to 5MHz offset. When not locked, the frequency display contains no offset and an Automatic Search is started in the direction given by the knob.

In Automatic Search, the Satlook G2 / HD checks the signal power at each 3 MHz interval and if the signal is a peak, it will attempt to lock using the current Modulation settings defined in the Setup/Modulations screen (DVB-S, DVB-S2, DVB-S Low Symbol rate). The Satlook G2 searches for QPSK signals. The search will stop when a signal is locked. Turning the knob re-starts the search in the direction of the knob turn. For Universal LNBs, if the frequency reaches 11900 MHz in low band, the 22kHz signal will automatically switch on and the search continues in high band. When searching down, when the frequency reaches 11520 MHz in high band, the 22kHz will automatically switch off and the search continues down.

The Search will end when a signal is locked or the frequency limits are reached. Manual Tuning can be entered using the Digital Menu and is active until the next press of the menu knob. With the Satlook HD, in order to lock on signals when the signal symbol rate is less than 15000 MSymbols/sec, the option "Low Symbol Rate" must be selected in the Setup Modulations. On both instruments, for symbol rates below 7000 MSymbols/sec, the signal identification may take several seconds.

A constellation pattern is shown which is formed from a small subset of the IQ decision points received by the demodulator. Occasionally, during an attempt to lock, a

calibration pattern can be observed momentarily. This is not a real signal, but is an artefact of the demodulator process.

The current state of the 22 kHz signal and the LNB voltage are displayed at the left. These are mirrored by the blue LED displays.

Once a transponder signal is locked, the Network Information is displayed at the top of the screen. This can take some time to appear once the transponder is locked. The first information that will appear is ONID (Original Network ID) and TSID (Transport Stream ID) data and then the NIT name and Orbital Position will follow. The ONID and TSID are displayed in hexadecimal. The transponder is supposed to send this data at least every 10 seconds, but sometimes there will be a transponder not sending any NIT data. Also you should be aware that sometimes a transponder will send incorrect satellite position data, because they are being used to repeat a transport stream used on another satellite.

Visible Thermometer Bars

There are four thermometer bars displayed to indicate the state of the signal being received. For all of these, the higher the thermometer bar, the better the signal quality. Each of these thermometer bars has the recent maximum displayed as a single bar. This maximum decays over time and so automatically allows for peaking adjustments. The four thermometer bars are SIG, SNR, BER and MER.

SIG

This is the power level of the **signal** at the current frequency. It is always displayed whether the signal is locked or unlocked. This is not the same as the display on the Analog screen.

SNR

This is the **signal to noise ratio** of the locked signal. This is a measure of the meaningful power in the signal to the background noise of the signal. It is shown in dB and is calculated by the demodulator using $SNR = 10\log_{10}(P_{signal}/P_{noise})$

BER

This is the **bit error ratio** of the signal. The lower this value is, the better the signal. It is shown in reverse on the thermometer bar for convenience so that a maximum can be easily found. For DVB-S QPSK signals, this is $BER = Error_{preViterbi}/(BitRate \cdot Time_{Lock})$. For DVB-S2 QPSK or 8PSK signals, the BER is estimated from the ratio of Un-correctable blocks to Correctable blocks.

MER

This is the **modulation error ratio** in dB. It is calculated from the constellation pattern and represents how close the I and Q decision points are to the ideal position. A typical MER value is 16 dB. A higher value is better and represents a closer spread of IQ decision points. A sample of 200 points is used for the calculation.

$$MER = 10\log_{10} \left(\frac{\sum (I_{ideal}^2 + Q_{ideal}^2)}{\sum (I_{error}^2 + Q_{error}^2)} \right)$$

Accessing the Digital Menu

When in the Digital Mode, turning the knob will change the current frequency. The Menu button will activate the Digital Menu.

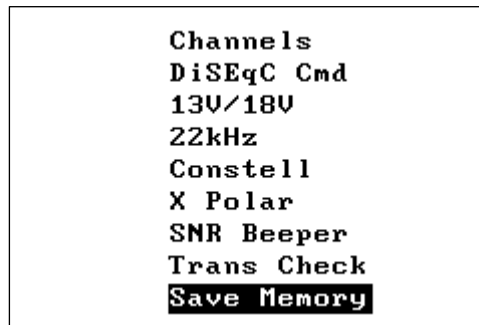
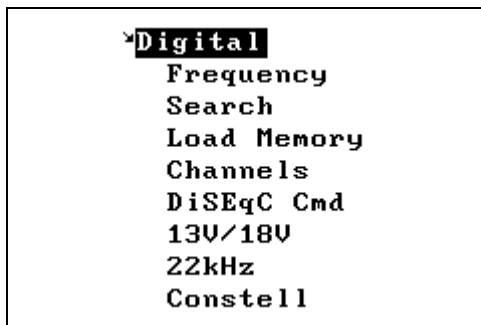

Frequency / Search

This function enters Digital Mode with the Search function disabled. Tuning can be performed manually using the knob. The manual tuning mode will remain active until the Search function is executed.

Load Memory

Load Memory Position			
9	EuW4	36E	11633V
10	EuW4	36E	12532H
11	Eur3	33E	11596V
12	Eur3	33E	11679V
13	Astra28E		11222H
14	Astra28E		11224V
15	Astra28E		12207V
16	Astra28E		12265H

The Load Memory function is used to load the settings for frequency, polarisation, and band from the permanent memory. The knob is used to select the desired memory and the knob button loads this memory. Once a memory location has been loaded, Load Mode is active. In Load Mode, turning the knob, turning the knob selects the next memory location, loads the memory and displays the memory number and name. To exit the load mode, the user presses the button once again and then the knob determines frequency on the Digital screen as before.

When a frequency is locked in Digital Load Mode, and NIT data is available, it replaces the memory position and name display, but if the knob is turned, then a new memory position is loaded and the memory position number and name displayed. This is replaced by NIT data when it is available.

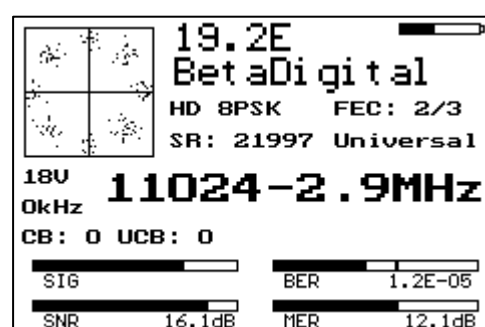
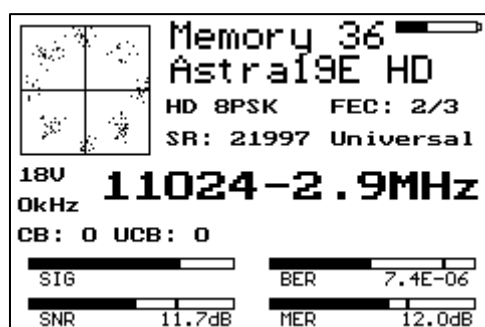

Channels

Service Data			
#	Type	ID Name	Provider
45	RA	4049 Hip Hop	BSkyB
46	RA	4050 Rewind (80s-90s	BSkyB
47	RA	4051 Chansons	BSkyB
48	TU	4090 Music Choice	BSkyB
49	TU	4091 Music Choice	BSkyB
50	RA	4152 EPG Background	BSkyB
51	83	4189 IEPG data 1	BSkyB
52	84	4190 DCS1	BSkyB
53	TU	7170	

This shows the services available on the current transponder. The type of service is shown in the first column. RA is a radio service, TV is a standard definition service and HD is a High Definition service. Other service types are listed by number. The Service ID number, Service Name and Service Provider are shown. The services shown will update as more services are found. The knob can be used to scroll up and down to see all of the services.

13V/18V

The LNB voltage can be switched from the Digital Menu.

22kHz

The 22kHz signal can be switched from the Digital Menu.

DiSEqC Command

This is the same as the function available on the Analog menu.

Constellation

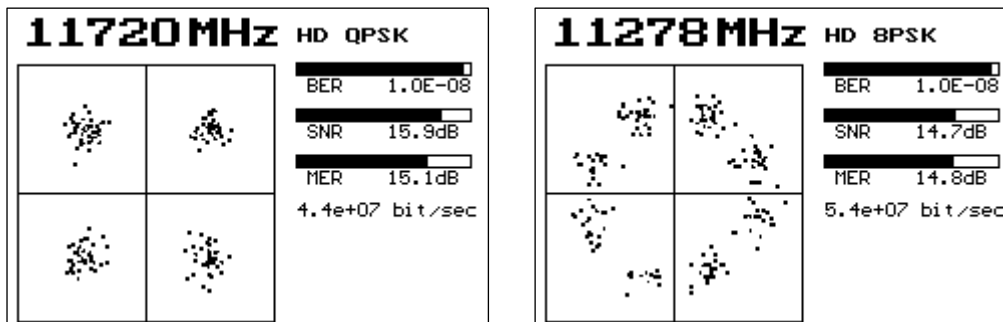

This function shows a larger version of the constellation presentation for a more detailed view. The current frequency is displayed at the top and rotating the knob will allow this to be changed. If locked, the current modulation is displayed along with the BER, SNR, and MER thermometer bars. The current Bit Rate of the transponder is shown with the Satlook HD. This information is not available on the Satlook G2.

X Polarity

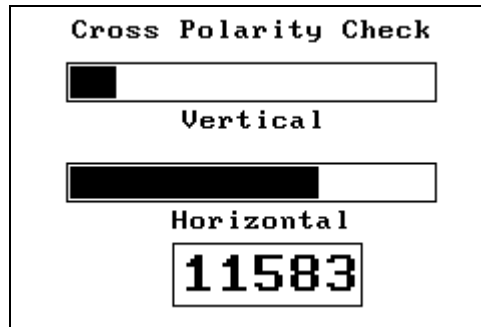

This function can provide a visual reference of the signal level of the vertical and horizontal polarisations at a frequency. This can be used to adjust the LNB skew for maximum isolation. Many satellite transponders (like Astra 28.2 for most frequencies) operate so that the vertical and horizontal polarisation signals are not usually at the same frequency, but others (like Hotbird) have some transponders that operate with vertical and horizontal polarisations at the same frequency. To ensure that you use a "good" transponder for this isolation test, use the Spectrum Analyzer to check the signals.

SNR Beeper

This function starts the beeper with a frequency depending on the current SNR reading. As the SNR increases, so does the frequency of the tone.

Transponder Check

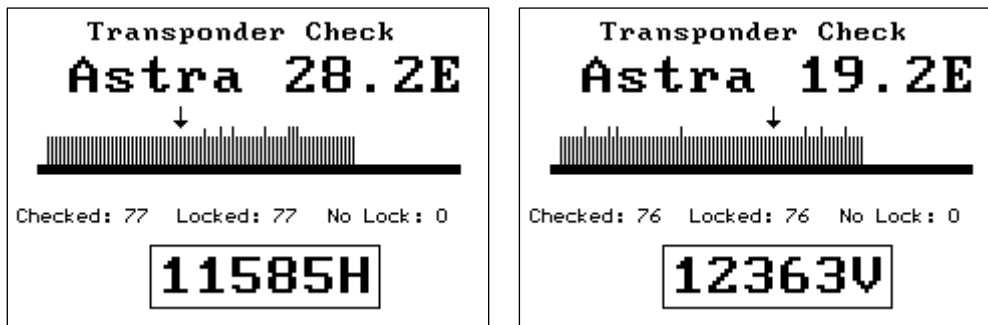

This function allows checking of all transponders for some satellites. The satellites that are testable with this function are Astra 28.2E, Astra 23.5E, Astra 19E, Hotbird 13E, Sirius 4.8E, and Thor 0.8W. When the function is started, the satellite to be tested is shown on the screen. Turning the knob selects a different satellite to be tested. Pressing the button starts the test. Each transponder on the satellite is checked and if locked, then an upward vertical line is shown. With the Satlook HD, if the transponder is DVB-S2, then the vertical line is shown slightly longer. On the Satlook G2, this transponder will fail to lock. If the transponder cannot be locked after three tries, then the vertical line is downward. At the completion of the test, the knob can be used to review any missing transponders and show the frequency and polarity for further checking using the Spectrum or Digital modes. Although all transponders for a satellite are tested, failure to lock may occur for several reasons. This is an accelerated test designed to run quickly and it is possible that the demodulator may not lock in the short time allowed, or the transponder may not have a broadcast "footprint" that covers your area.

Save Memory

Save Memory Position			
9	EuW4	36E	11633V
10	EuW4	36E	11679H
11	Eur3	33E	11596V
12	Eur3	33E	11679V
13	Eur3	33E	11472V
14	Astra28E		10817V
15	Astra28E		10832H
16	Astra28E		12207V

The Save Memory function saves the current Frequency, Polarity (13V/18V), Band (22kHz signal state), and LNB Type in the selected location. The knob can be turned to select the desired memory position to change. If a new name is needed for the memory position, then it can be entered on the next screen when the menu button is pressed to select the memory position number.

Save or Change Name	
W6 21E	
ABCDEFGHIJKLMNOPQRSTUVWXYZ	
0123456789 +- / = , . : () _ & @	
Clear	Delete
Cancel	Save

If the memory location name is already correct, then press the menu button again to save the frequency data in this memory position. If the name needs to be changed, use the knob to make the changes. Characters can be added by selecting the character with the knob and then pressing the menu button. Characters can be deleted by selecting the "Delete" function with the knob and then pressing the menu button. "Clear" will erase the name, and "Cancel" will abort saving the memory position.

Spectrum Mode

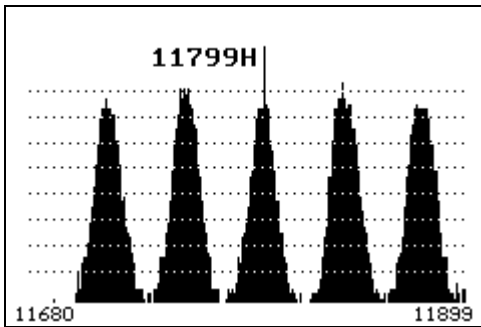

G2 Spectrum

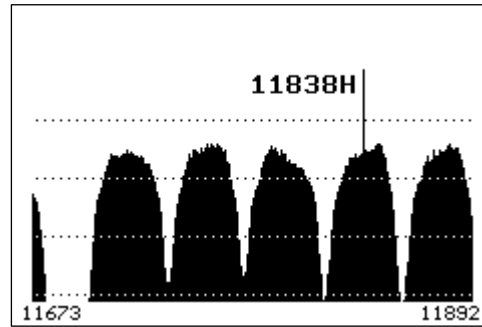

HD Spectrum

About Spectrum Mode

The Spectrum Mode shows the signal power versus frequency around the current frequency. On entry to the Spectrum Mode, the spectrum cursor is in the centre of the display and the centre frequency is set to the last used frequency. Turning the knob changes the cursor frequency, and the flag shows the current cursor frequency and for a Universal LNB also shows the Polarity. If the cursor frequency is adjusted to a position that would be offscreen, the screen is cleared and the spectrum plotted with the cursor at the new frequency in the centre. The current frequency is used for other modes, so the Spectrum Mode can be used to find a signal of interest, and then the Digital Mode can be used for more complete examination. The user can exit Spectrum Mode by pressing the button.

Accessing the Spectrum Menu

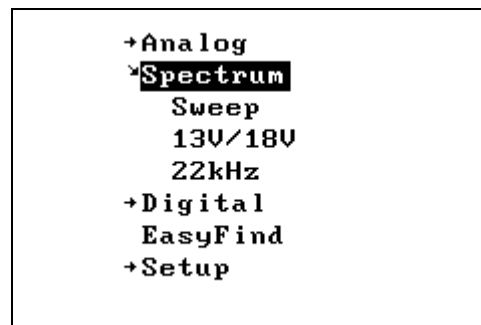

The Menu is activated by pressing the button. At this time, the Spectrum options can be changed or other functions in the menu can be used.

Sweep

The Spectrum Sweep can be changed from 1 MHz per increment to 10 MHz per increment. The user setting for the Spectrum Sweep increment is then saved and restored on power up.

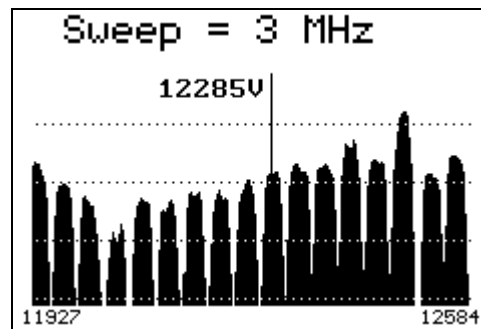

13V/18V and 22kHz

From the Spectrum Menu, the Polarity and Band can be changed with the 13/18V and the 22kHz signal.

Analog Mode

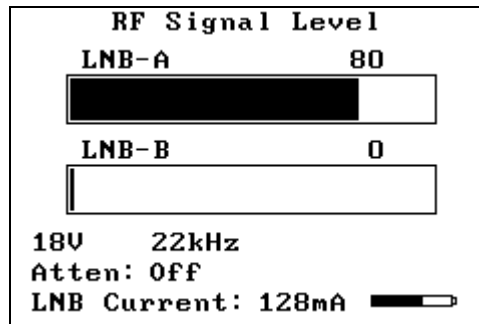

About Analog Mode

The screen in Analog mode shows the relative RF level for the two LNB inputs on a thermometer bar. This is the RF level for the IF band from 920 MHz to 2150 MHz. For a Universal LNB, the Satellite band will be selected from one of the four quadrants by the 13V/18V and the 22 kHz signal. The LNB voltage of 13V or 18V is displayed by the blue LEDs and also on the screen. The LNB signal 22kHz is displayed by the blue LEDs and also on the screen. The Attenuator state is shown on the screen and is displayed by the blue LEDs.

The LNB Current is displayed. Typical LNB current will range from 90 to 175 mA. If there is a short in the satellite cable to the LNB, the screen will show an overcurrent condition. When both LNB-A and LNB-B are connected, you will see the combined LNB Current. If the LNB Current exceeds about 450mA, then the LNB Voltage of 13V/18V will be turned off.

Power Display

The battery charge level is shown approximately by the battery symbol. When the Satlook G2 / HD is connected to a power supply, the battery symbol is replaced by "Ext Power".

Accessing the Analog Menu

When in the Analog Mode, turning the knob or pressing the knob button will activate the Analog menu for the Analog functions.

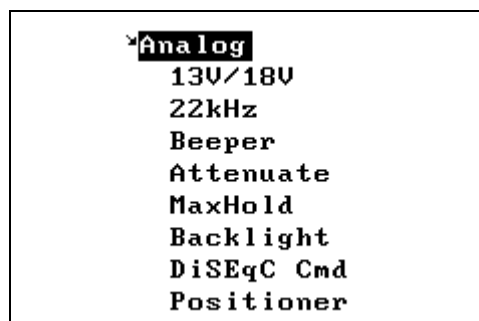

Rotating the knob will scroll through the menu items. To select a menu item, press the menu button. If the *Menu Timeout* function (set using Setup mode) is set, then the display will revert to the Analog Mode display after a timeout, otherwise the Analog menu will continue to be displayed until an Analog function is selected from the Analog menu.

Analog Menu Functions

13V/18V

This function toggles the LNB voltage. If the voltage is 13V, it is changed to 18V and vice versa. The LNB voltage is used to select the Polarity for a Universal LNB. 13V selects Vertical Polarity and 18V selects Horizontal Polarity. The user setting for the LNB voltage is saved and restored on power up.

22kHz

This function toggles the LNB 22kHz signal. If the signal is off, it is turned on and vice versa. The 22 kHz signal selects the band for a Universal LNB. If the 22 kHz signal is off, then a Universal LNB selects the low band (10670 MHz to 11900 MHz). If the 22 kHz signal is on, the high band is selected (11520MHz to 12750MHz). The overlap region from 11520MHz to 11900MHz can be received with the 22 kHz signal either on or off. The user setting for the 22 kHz signal is saved and restored on power up.

Beeper

This function toggles the RF signal beeper to one of three modes. The frequency of the beeper increases with RF signal strength.

- if off, it is set to use the RF signal from LNB-A
- if currently LNB-A, then it is set to use the RF signal from LNB-B
- if LNB-B, it is set to off

Attenuate

This function toggles the RF attenuator on or off. This inserts about 3dB into the RF path. It attenuates both LNB-A and LNB-B. There is no effect on signals in Digital Mode.

MaxHold

This toggles the MaxHold function from off to on and vice versa. When the MaxHold function is on, the maximum RF signal value for LNB-A and LNB-B is displayed as a line on the thermometer bar.

DiSEqC Cmd

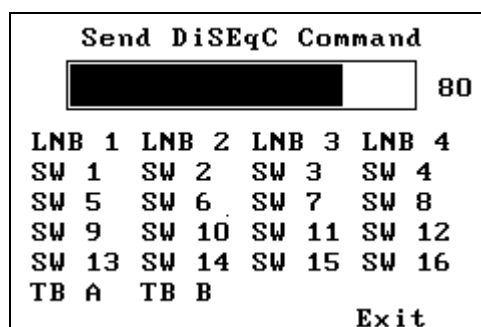

This function sends a DiSEqC command. Turning the knob shows the DiSEqC command selected and pressing the knob button sends this command. The thermometer bar shows the RF Level for LNB A. This is RF level for the IF band from 920 MHz to 2150 MHz. The *Exit* position returns the user to Analog mode. The DiSEqC commands that are sent are detailed in appendix C (DiSEqC Primer).

Positioner

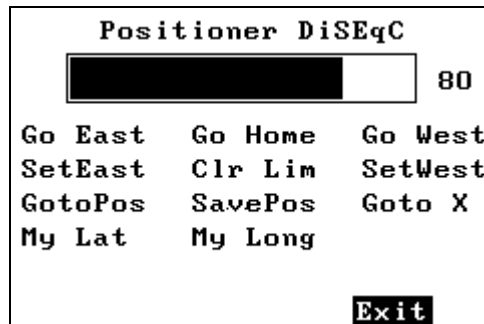

This function sends a DiSEqC command to a positioner. Turning the knob shows the DiSEqC command selected. Pressing the knob button will then send this command. The thermometer bar shows the RF Level for LNB A. This is RF level for the IF band from 920 MHz to 2150 MHz. The *Exit* position returns to the Analog Mode. The DiSEqC commands that are sent are detailed in Appendix C (DiSEqC Primer).

Go East: This sends the DiSEqC command to move the positioner to the East. As long as the button is pressed, the movement continues. When the button is released, a DiSEqC Halt command stops the motion.

Go Home: This sends the command to "Home" the positioner. (This command is Goto Pos 0) This is normally due South, but for some positioners may be the extreme easterly limit.

Go West: The DiSEqC command to move the positioner to the West. As long as the button is pressed, the movement continues. When the button is released, a DiSEqC Halt command stops the motion.

SetEast: Set the East "soft" limit for the positioner at the current position.

Clr Lim: Clear the "soft" limits.

SetWest: Set the West "soft" limit for the positioner at the current position.

Goto Pos: This sends the DiSEqC command to the positioner to move to a stored position from 1 to 31. The knob selects the position number to move to and pressing the knob button sends the command.

Save Pos: This sends the DiSEqC command to the positioner to save the current position as a "stored" position from 1 to 31. The knob selects the position number that this will be called and pressing the knob button sends the command.

Goto X: This sends the DiSEqC command to move to a position calculated for the Satellite Angle desired. The knob selects the Satellite Angle that will be used and

pressing the knob button sends the command. To move the positioner to HotBird for example, the command to send would be Goto X 13.0 E. The Goto X function calculates the amount to move the positioner from the Satellite Angle and the user Latitude and Longitude. In order for the command sent to be correct, the Latitude and Longitude must be set for the user location.

MyLat: This function is for the entry of the Latitude of the user location. Turning the knob will show the selected latitude from 90.0° South to 90.0° North and pressing the knob button will save this setting. This setting will be restored on power on.

MyLong: This function is for the entry of the Longitude of the user location. Turning the knob will show the selected Longitude from 180.0° East to 180.0° West and pressing the knob button will save this setting. This setting will be restored on power on.

Setup Functions

```
*Setup
Contrast
Invert Knob
Invert Scrn
Auto Off
Backlght Cfg
Set LNB Type
Modulation
StartUp Mode
```

```
Backlight Config
Set LNB Type
Modulation
StartUp Mode
Menu TimeOut
EasyFind Setup
UniCable Band
Language
Version
```

Contrast

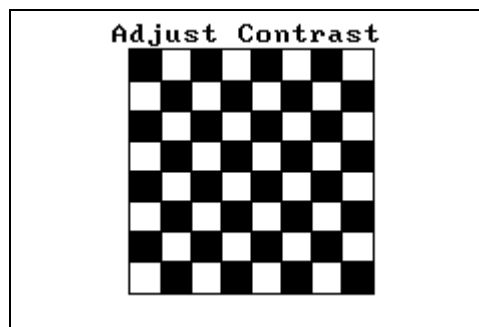

The Contrast function shows a black and white grid and allows the adjustment of the display contrast for best viewing using the knob. Pressing the knob button exits the contrast adjustment and saves the current contrast settings.

Invert Knob

Pressing the Knob button for the Invert Knob function changes the way the knob rotation is interpreted. At default, rotating the knob clockwise means that frequency will increase and the menu selection will move down to the next selection. This is saved as a power on parameter.

Invert Scrn

Pressing the knob button for the Invert Scrn function will invert the screen, black to white and vice versa. This is then saved as a power on parameter.

AutoOff Timeout

```
AutoOff TimeOut
No AutoOff
■ 5 minutes
15 minutes
30 minutes
60 minutes
Exit
```

This function sets the AutoOff timeout if required. If the knob button or knob is not used for the timeout period, then the Satlook will display "AutoOff" and power down. This setting is then saved as a power on parameter.

Backlight Configuration



The backlight can be set so that it will turn off after a delay. The setting is then saved as a power on parameter.

Set LNB Type

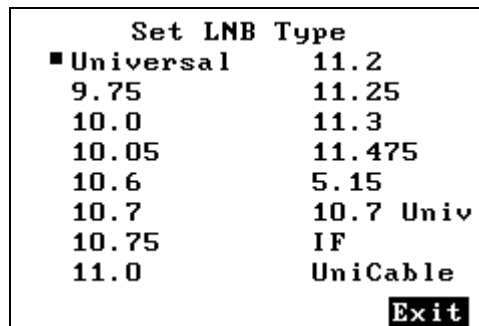

The LNB used can be set so that the frequency displayed is correct and the stored transponders are correctly used.

The "Universal" entry sets the LNB so that two local oscillator frequencies (9750MHz and 10600MHz) are used for conversion. These are switched using the 22kHz signal to select the 9750MHz local oscillator when the 22kHz is off and the 10600MHz local oscillator when the 22kHz is on. The LNB downconverts the satellite signal to the Intermediate Frequency as:

$$IF = \text{Frequency}_{\text{Satellite}} - \text{Frequency}_{\text{LO}}$$

The "10.7 Univ" entry is similar except that the two local oscillator frequencies are 9750MHz and 10700MHz.

The "5.15" LNB type is for C Band. The LNB downconversion for this LNB is:

$$IF = \text{Frequency}_{\text{LO}} - \text{Frequency}_{\text{Satellite}}$$

The "IF" entry uses no conversion. The frequency displayed is in the 950MHz to 2150MHz band.

UniCable LNB selection uses the tuning commands for UniCable. The User Band default is 1 and can be changed using the Setup -> UniCable Band command (see page 22). This

command is also used to test the four User Bands. The User Bands are assumed to be 100 MHz wide. (Using the Spectrum mode will show how wide the User Band is and whether it is symmetrically about the tuning frequency.) In the Digital mode, retuning is performed every time the frequency is changed using the knob or the Band/Polarisation is changed. In the Spectrum mode, no retuning is performed while the cursor is within the UniCable Band of 100MHz. To force the retuning, exit the Spectrum mode and re-enter. Entry to the Digital Mode and Spectrum mode force UniCable re-tuning. During UniCable LNB use, the 13V/18V and the 22kHz signal indications are still used for Polarisation and Band selection, but they are not actually imposed on the LNB cable.

Modulation

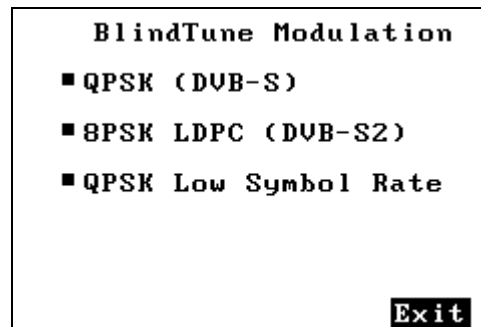

This function is only available with the Satlook HD. It sets the modulation type that will be tried when in the Digital Mode. This can be used with the search function to find only transponders that are DVB-S or DVB-S2. The BlindTune algorithms used will search for Symbol Rates from 15000 to 30000. In addition, the Low Symbol rate option can be enabled to allow the search for Symbol Rates from 1000 to 15000. This will search for QPSK only in this region. This option adds extra time to the BlindTune algorithm so that when these low symbol rates are not needed, it should be turned off. This setting is a power up parameter.

StartUp Mode

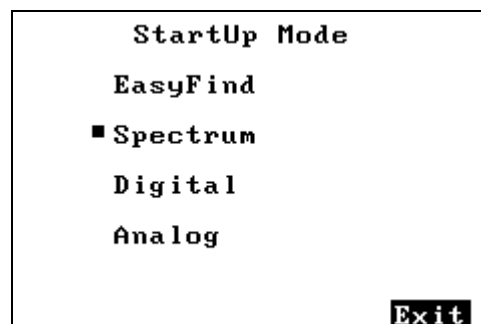

The mode on power up can be chosen for the Satlook G2 / HD. This setting is a saved parameter.

Menu Timeout

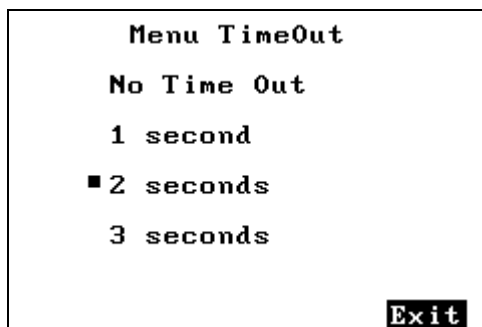

The menu timeout can be set so that if no action is performed, then the display of the current mode will resume automatically. If "No Time Out" is chosen, the menu will remain active until the button is used to select a function.

EasyFind Setup

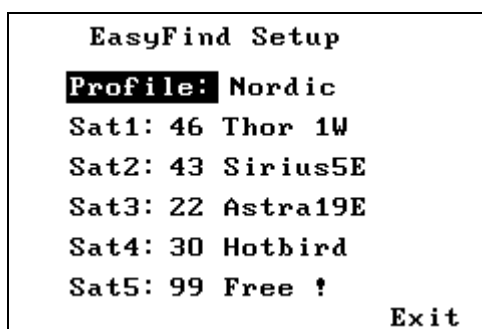

The EasyFind Setup function allows the EasyFind to be configured for the user situation. The "Profile" can be selected with the knob button and one of five profiles stored in memory can be selected. An additional Profile "All Sats" allows the use of any memory position in EasyFind Mode. When the Profile is defined, the five Satellites in the profile can be selected from the memory positions.

UniCable Band

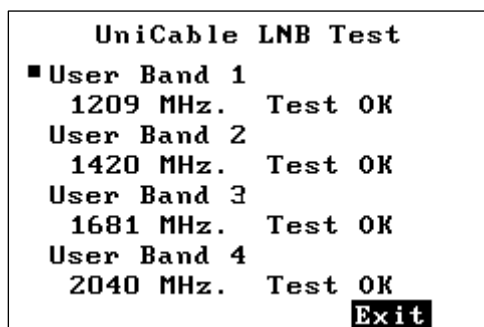

The UniCable User Band used for tuning can be selected to be other than the default of User Band 1. At the start of this function, the four User Bands are verified. After this test, any of the four bands can be selected as the User Band to be used for tuning for detailed testing of the UniCable LNB. The User Band can be selected regardless of the test results, so the User Band could be set with the LNB disconnected. The power up default of the User Band is 1. If the User Band is already in use by another receiver, then the test will fail for this User Band.

Language

The menu language can be set to other languages than English. Supported are Swedish, French, German, Polish, Dutch, Spanish, and Italian.



Version

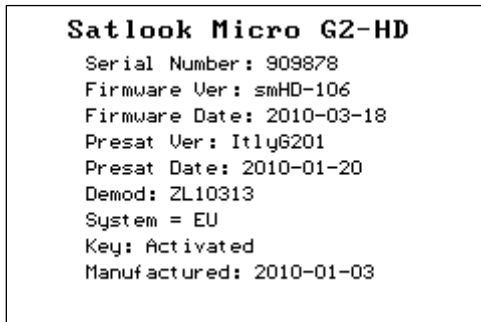

Satlook G2

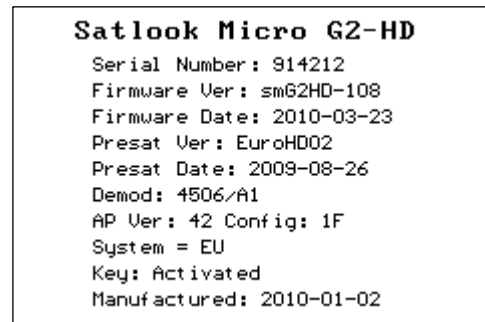

Satlook HD

The Version menu shows the software and hardware versions and related information.

Loading New Firmware

A new firmware version can be loaded to correct issues that are reported in the firmware release notes. The firmware for the Satlook HD is identified as "smHD60-EU.hex" with the number "60" being the version number. Newer firmware designed to be common with the Satlook G2 is identified as smG2HD106-EU.hex This firmware can be used on either the G2 or the HD. Do not load any firmware without these types of name, it will be for a different instrument and will not work on the Satlook G2 or HD. Use the Version screen in the Setup Menu to determine the current software version.

In order to load firmware, you must have a PC which supports an RS232 connection. The firmware loading must be performed with the external charger connected. The RS232 cable to be used is supplied as part of the kit with the Satlook G2 / HD. Some laptops do not have an RS232 connection, but a USB to RS232 adapter can be purchased at low cost. Connect the Rs232 cable from the computer to the instrument. Run the firmware download file "FDL.exe".

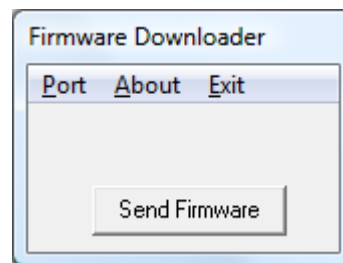
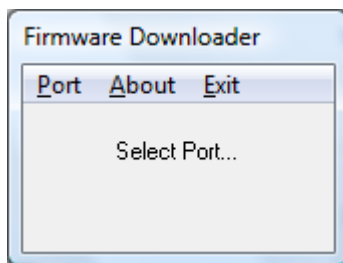

Select the RS232 port on the computer. Normally, the port is COM1 but some USB to RS232 will use some other port. If desirable, this USB to RS232 conversion device can be made to always use COM1 by clicking Control Panel / Device Manager / Ports and in the Advanced settings for the adapter set to COM1.

Select "Send Firmware" and the display will be "Searching". Connect the Satlook G2 / HD to the external charger and the display will change to "Found". To verify this, check the Blue LEDs to see if they are not changing. If they are in cycling pattern displaying the "charging pattern" then the process must be restarted. An alternative method of starting the firmware loading process is to have the Satlook G2 / HD connected to the external charger and charging when starting the firmware load. When the "Searching" message is displayed, momentarily press the Power On button for less than a second. It is only during power up under external charge that the unit will check for an RS232 connection for firmware loading. Now choose the firmware file. Normally, the firmware will be in the same direction as "FDL.exe" but if not, you can navigate to the correct directory and select the firmware file. Once the file is selected, the firmware loading will take about 10 minutes and then the Firmware Downloader program will display "Download Complete" and the Satlook G2 / HD will revert to the "charging pattern" shown by the blue LEDs in a cycling pattern.

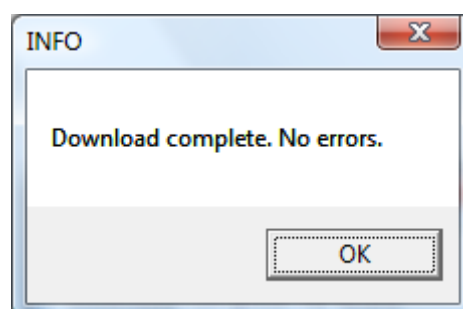

Using PC to transfer transponder data

The transponder data in the Satlook G2 / HD is stored in permanent memory. The transponder data is stored in 100 memory positions that contain the Name, Frequency, LNB type, LNB voltage 13V/18V, 22 kHz signal state, etc. It also contains the EasyFind setup data. This data can be loaded to the Satlook G2 / HD from a PC or Satlook G2 / HD data can be saved on the PC for backup. The data is saved on the PC as filetype *.smd. For a full description of this file, see Appendix E.

In order to transfer the satellite data, you must have a PC which supports an RS232 connection. The data transfer is performed with the instrument turned on and either battery powered or connected to the external. The RS232 cable to be used is supplied as part of the kit with the Satlook G2 / HD. Some laptops do not have an RS232 connection, but a USB to RS232 adapter can be purchased at low cost. Connect the RS232 cable from the computer to the instrument. Run the data transfer file "micromem.exe".

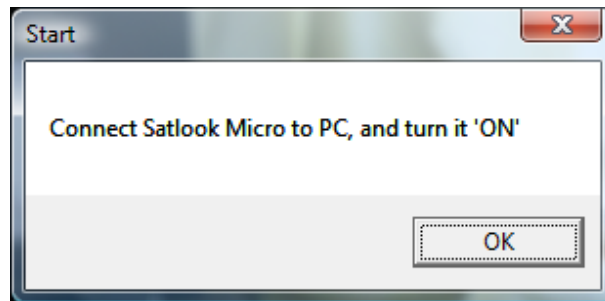

When the Satlook G2 / HD is turned on, the micromem program will identify the RS232 port being used, and then the transfer screen will be active.

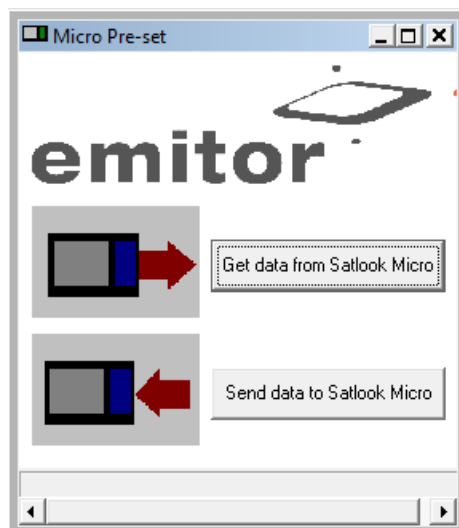

The data transfer can be performed when the Satlook G2 / HD is in the Analog mode or when a menu is being displayed. Transferring data when the Satlook G2 / HD is in the Digital Mode or the Spectrum Mode should be avoided because the unit is very busy during these modes.

To send the data, select the Send Data button and a file dialog will be presented to choose the appropriate *.smd file. To save the Satlook G2 / HD transponder data for later backup, choose the Get Data button and the file dialog will be presented to name the file.

Appendix A – Saved Parameters

These parameters are saved on power down of the Satlook G2 / HD and restored on power up. They are not saved in the *.smd Transponder files.

LNB Type
AutoOff Value
Contrast Value
Last Memory Value Loaded
MyLatitude
MyLongitude
Spectrum Sweep value
13V/18V
22kHz
Last used Frequency
Invert Screen state
Invert Knob state
BacklightTimeOut
EasyFind transponder number
EasyFind profile
BlindTune_Modulations
MenuTimeOut

Appendix B – Universal LNB Primer

The LNB (low noise block amplifier) has evolved since its early introduction in Satellite broadcasting. Signals broadcast from satellites are 10600 MHz to 12700 MHz for Ku band and 3000 MHz to 4500 MHz for C band. Because the losses in coax are quite high for these frequencies, the satellite signal is first downconverted to a more manageable 950 MHz to 2150 MHz for transmission from the dish to the receiver. This is called the IF (intermediate frequency) or also the L Band. Most of the European broadcasting is in the Ku band. The satellite transmission can use either horizontal or vertical polarisation. This is a way of re-using the available spectrum since there can be two transponders at the same frequency with different polarisations. The Universal LNB can receive either horizontal or vertical polarisations depending on the LNB line voltage. 13V is used to select Vertical polarisation and 18V is used to select Horizontal polarisation.

The Ku band for satellite reception is 2100 MHz wide (12700 – 10600) while the receiver input is only 1100 MHz wide (2150 – 950). To allow the full reception of the entire Ku band, two different local oscillator (LO) frequencies are used in the Universal LNB. This LO frequency is switched in the Universal LNB by using the 22 KHz tone. When it is off, then the LO frequency used is 9750 MHz and when on, 10600 MHz is used.

The four frequency ranges for the Universal LNB are sometimes called quadrants and is diagrammed below showing the overlap.

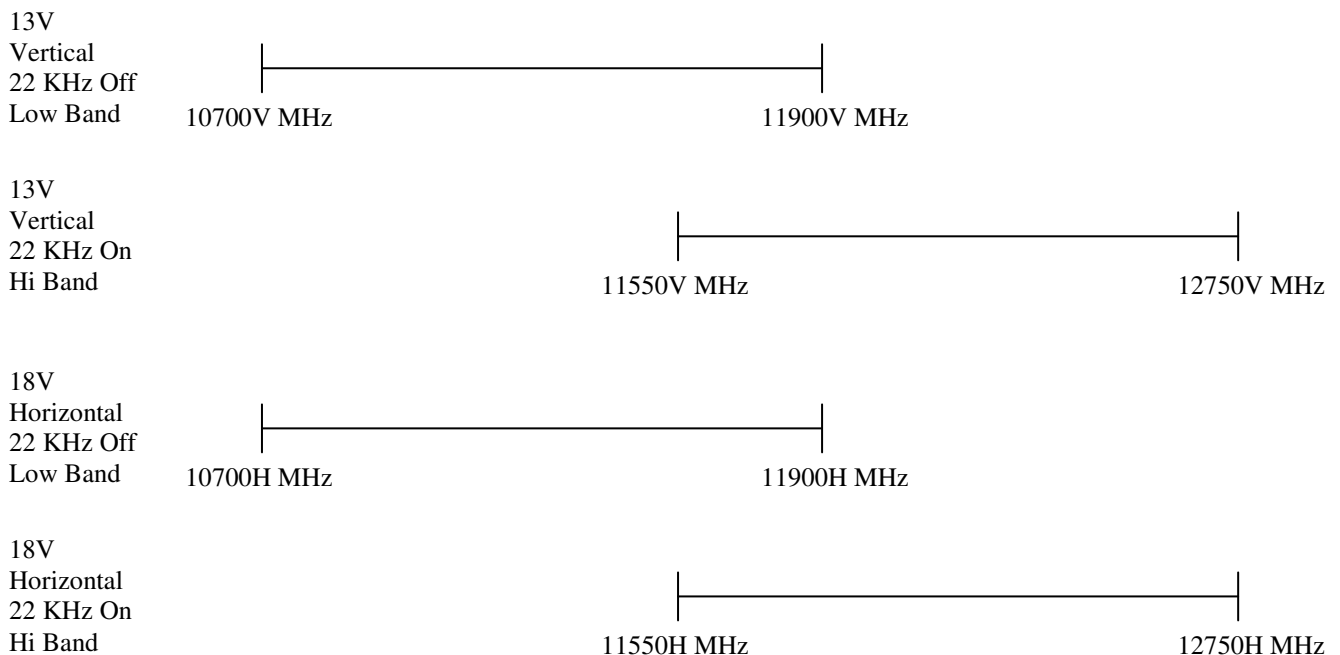

Appendix C – DiSEqC Primer

About DiSEqC

DiSEqC is an acronym for “Digital Satellite Equipment Control” and is achieved using the 22kHz signalling tone. The 22 kHz signal is imposed on the LNB DC voltage of 13V or 18V at a level of 0.65V p-p. Normally, the 22kHz signal is either continuously on or off. When a DiSEqC message is to be sent, if the 22kHz is on, it is turned off for a “quiet period” before the message. Then the DiSEqC message is sent as a series of bytes with an odd parity bit appended. The bits are formed by modulation of the 22kHz signal as shown below.

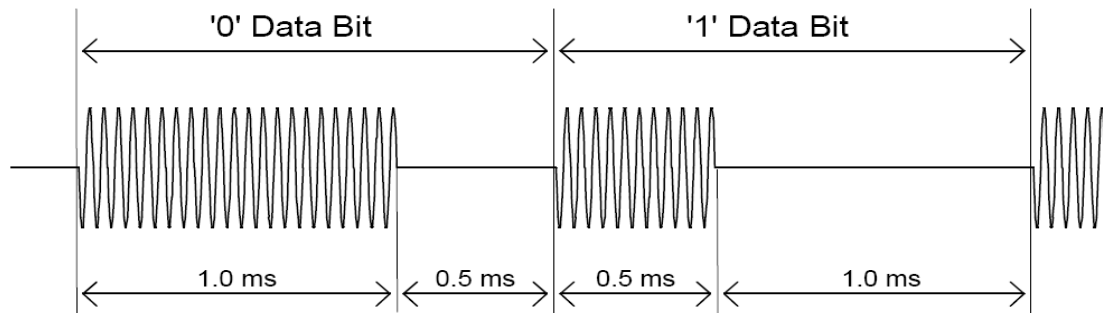

Most DiSEqC commands are 3 bytes in length but some can be up to 6 bytes long, so the transmission time of a DiSEqC message is on the order of 40 to 80 milliseconds.

DiSEqC Commands

LNB1: 0xe0, 0x10, 0x38, 0xc0

LNB2: 0xe0, 0x10, 0x38, 0xc4

LNB3: 0xe0, 0x10, 0x38, 0xc8

LNB4: 0xe0, 0x10, 0x38, 0xcc

SW1: 0xe0, 0x10, 0x39, 0xf0

SW2: 0xe0, 0x10, 0x39, 0xf1

SW3: 0xe0, 0x10, 0x39, 0xf2

SW4: 0xe0, 0x10, 0x39, 0xf3

SW5: 0xe0, 0x10, 0x39, 0xf4

SW6: 0xe0, 0x10, 0x39, 0xf5

SW7: 0xe0, 0x10, 0x39, 0xf6

SW8: 0xe0, 0x10, 0x39, 0xf7

SW9: 0xe0, 0x10, 0x39, 0xf8

SW10: 0xe0, 0x10, 0x39, 0xf9

SW11: 0xe0, 0x10, 0x39, 0xfa

SW12: 0xe0, 0x10, 0x39, 0xfb

SW13: 0xe0, 0x10, 0x39, 0xfc

SW14: 0xe0, 0x10, 0x39, 0xfd

SW15: 0xe0, 0x10, 0x39, 0xfe

SW16: 0xe0, 0x10, 0x39, 0xff

TBA: Tone Burst 0 to select satellite A

TBB: Tone Burst 1 to select satellite B

Go East: 0xe0, 0x31, 0x68, 0x1e

Go Home: 0xe0, 0x31, 0x6b, 0x00

Go West: 0xe0, 0x31, 0x69, 0x1e

Set East: 0xe0, 0x31, 0x66
Clr Lim: 0xe0, 0x31, 0x63
Set West: 0xe0, 0x31, 0x67
Goto Pos: 0xe0, 0x31, 0x6b, <Position Number 1 to 31>
Save Pos: 0xe0, 0x31, 0x6a, <Position Number 1 to 31>
Goto X: 0xe0, 0x31, 0x6e, <Movement High Byte>, <Movement Low Byte>

For the full DiSEqC specifications, see http://www.eutelsat.com/satellites/4_5_5.html)

Appendix D DVB-S and DVB-S2 Primer

DVB-S and DVB-S2 both use phase shift keying to digitally modulate a carrier. Quadrature phase shift keying is used in both and the digital data is encoded as a 90 degree phase shift in the signal. This gives 4 possible states for each sampling interval. The sampling interval is called the Symbol Rate and each state of 2 bits is a Symbol. During transmission, this data is interleaved to allow recovery during noise bursts and redundant data is added called FEC (forward error correction). During reception, the data is re-shuffled to restore the order and the FEC data is used to correct the bitstream as necessary. In DVB-S2, 8PSK (octal phase shift keying) can be used in transmission where there are 8 possible states from a 45 degree phase shift in the Analog signal. A different scrambling and FEC for DVB-S2 allows better noise immunity.

The bitstream output for both DVB-S and DVB-S2 is the same. This bitstream is called "transport stream". A transport stream is made up of packets. All packets are the same length of 188 bytes and they all start with the sync byte 0x47 so that when the data is read, a starting point can be located. Each packet also contains a PID (packet identification). The information in the transport stream consists of several video and audio streams and also SI tables (Service Information) to allow the receiver to decode and display the correct data. There are several types of tables in the SI called PSI data. This table data is generally longer than one packet so several packets are assembled together to make a "section" which can be up to 1024 bytes.

- 1) Program Association Table (PAT): for each service in the multiplex, the PAT indicates the PID of the corresponding Program Map Table (PMT). It also gives the location of the Network Information Table (NIT).
- 2) Program Map Table (PMT): the PMT identifies and indicates the PIDs of the video, audio, and other streams that make up each service.
- 3) Network Information Table (NIT): the NIT gives the Network Number, Name and Satellite Position of the satellite. It also lists all the other transponders on the satellite.
- 4) Service Description Table (SDT): the SDT gives information about each service in this transport stream.

Once these tables are decoded by the receiver, the correct PID for the audio and video streams can be found and presented to the video and audio decoders. In DVB-S, the video streams are presented in MPEG-1 or MPEG-2 encoding (usually MPEG-2). For DVB-S2, the video streams can be presented in these formats or in the newer HD format MPEG-4.

(For a more complete understanding, see ISO 13818-1 "Information technology, Generic coding of moving pictures and associated audio information: Systems" and DVB EN 300 468 "Specification for Service Information")

Appendix E UniCable Primer

UniCable or SCIF (Single Cable Interface) is a method of translating Satellite frequencies from the LNB to the user. It is intended to allow multiple receivers to share the same coaxial cable.

With a standard Universal LNB, with Horizontal and Vertical polarity and low and high band, there are four frequency ranges that can be selected from the LNB by using the 13V/18V and the 22kHz signal. In order to allow multiple receivers to operate using a single coax cable, UniCable operation requires the receiver to send the desired frequency using a DiSEqC command. A UniCable LNB or Switch may be used. For a UniCable Switch, the LNB input is usually a Quattro LNB which provides the four frequency ranges to the switch. For a UniCable LNB, the Switch and the Quattro LNB are integral.

To tune a frequency on the UniCable LNB (or Switch), the receiver issues a DiSEqC command which indicates the Satellite Frequency needed, the Polarisation, the Band and what User Band to use. The number of User bands differs but normal is 4 or 8.

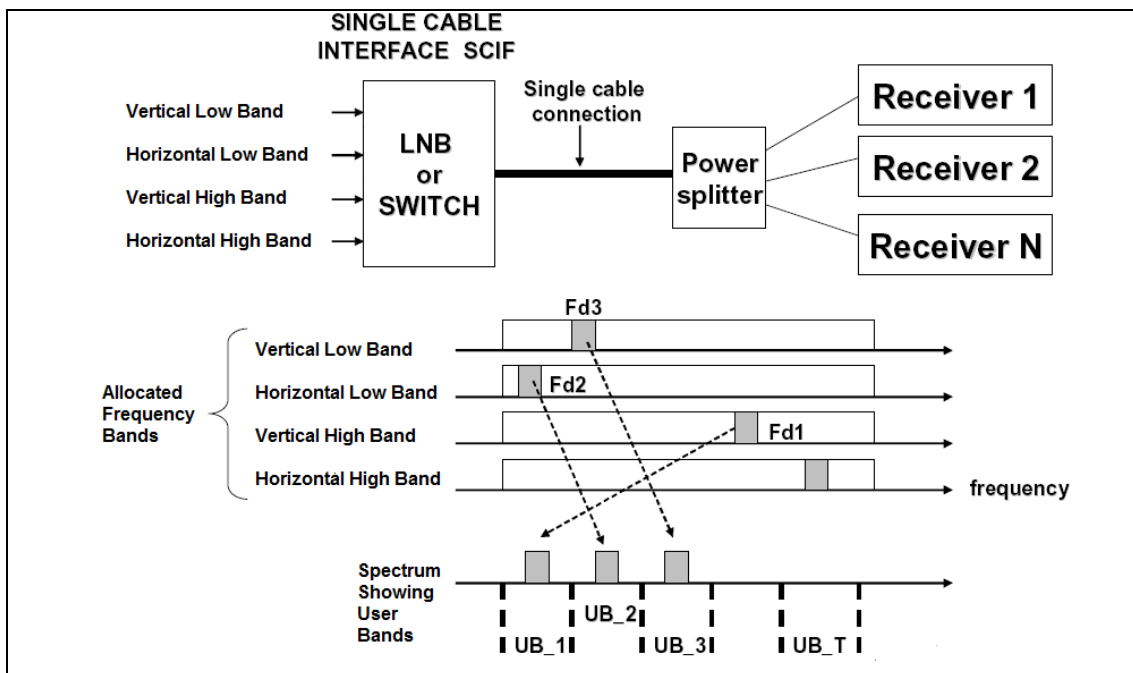

The User Bands which are available can be determined by sending a DiSEqC command to emit RF tones at the centre frequencies of the User bands. By scanning the frequencies, the User Bands are located. To find out what number User Band this is, another DiSEqC command is sent to turn off the tone at User Band XX. By selectively turning the RF tones off, the number of the User Band is determined. Alternatively, The User Band Frequency allocation is usually provided on the LNB/Switch description. The placement of the User bands within the spectrum is not the same between manufacturers.

For further detail on UniCable, see the specification EN 50494 – Satellite signal distribution over a single coaxial cable in single dwelling installations.

UniCable Commands: (only the 5 byte commands are shown)

ODU_Power_OFF: (0xe0 0x00 0x5a D1 0x00)

Turn power off for the selected User Band.

D1 is defined as bit 5,6,7 select the User Band and bit 0,1,2,3,4 = 0;

ODU_UBxSignal_ON: (0xe0 0x00 0x5b 0x00 0x00)

Generate an RF tone at the centre of each User Band.

ODU_Config: (0xe0 0x00 0x5b D1 D2)

D1 is defined as bit 5,6,7 select the User Band and bit 0 = 1, bit 1,2,3,4 = 0;

Generate an RF tone answer at the selected User Band for the question in D2

ODU_LoFreq: (0xe0 0x00 0x5b D1 D2)

D1 is defined as bit 5,6,7 select the User Band and bit 1 = 1, bit 0,2,3,4 = 0;

Generate an RF tone answer at the selected User Band for the question in D2

ODU_Channel_change (0xe0 0x00 0x5a D1 D2)

D1 is defined as D1 is defined as bit 5,6,7 select the User Band, bit 3 selects polarisation, bit 2 selects low/high band, bits 0,1 of D1 and D2 are 10 bit Tuning Word.

$$TuningWord = (F_{Satellite} - F_{LO} + F_{UserBand}) / 4 - 350$$

Appendix G – Satlook G2 Specifications

- Automatically acquires DVB-S transponders using advanced demodulator to determine FEC and Symbol Rate.
- Input frequency: 920-2150MHz
- Input level: 35-100 dBuV
- Input/output impedance: 75 Ohm, F-connectors
- Measuring method (Analog):
 - RF Signal presentation in thermometer scales for both LNB inputs
 - Loadspeaker tone changes with signal level when enabled
- Spectrum Analyzer 950 MHz to 2150 MHz, step size 1 MHz to 10 MHz
- Measuring method (Digital):
 - BER (bit error rate)
 - MER (modulation error ratio)
 - SNR (signal/noise-ratio)
 - Constellation (QPSK and 8PSK)
- Max-level: - Thermometer scales showing max
- Maxhold function with BER, SNR and MER showing maximum values
- Satellite identification: By reading the NIT in the transport stream
- Channel Information: reading the SDT showing TV and Radio channels available
- Memory: 100 transponders can be stored with name
- Memory locks on: FEC, Symbol-rate Frequency, 13V/18v, 22kHz
- Display: LCD 3 inch display
- PC connection: RS232 with DB9 connector
- LNB Power: 13V or 18V supplied on both LNB-A and LNB-B
- 22 kHz tone: Standard 22 KHz signal superimposed at 0.65V p-p on LNB-A
- DiSEqC: Yes, all 1.0 and 1.1 commands supported
- DiSEqC: Positioner commands for DiSEqC 1.2 and GoToX
- Battery: Rechargeable 12v, 1.8 amp/hour
- Battery Life: About 2 hour on a fully charged battery
- Weight: About 1.5 kg including battery
- Accessories: Nylon carrying case
- Power-supply of 220v/13.8v, 1.5 amp
- Car-charger

Appendix H – Satlook HD Specifications

- Automatically acquires DVB-S and DVB-S2 transponders using advanced demodulator to determine FEC and Symbol Rate.
- Input frequency: 920-2150MHz
- Input level: 35-100 dBuV
- Input/output impedance: 75 Ohm, F-connectors
- Measuring method (Analog):
 - RF Signal presentation in thermometer scales for both LNB inputs
 - Loadspeaker tone changes with signal level when enabled
- Spectrum Analyzer 950 MHz to 2150 MHz, step size 1 MHz to 10 MHz
- Measuring method (Digital):
 - BER (bit error rate)
 - MER (modulation error ratio)
 - SNR (signal/noise-ratio)
 - Constellation (QPSK and 8PSK)
- Max-level: - Thermometer scales showing max
- Maxhold function with BER, SNR and MER showing maximum values
- Satellite identification: By reading the NIT in the transport stream
- Channel Information: reading the SDT showing TV and Radio channels available
- Memory: 100 transponders can be stored with name
- Memory locks on: FEC, Symbol-rate Frequency, 13V/18v, 22kHz
- Display: LCD 3 inch display
- PC connection: RS232 with DB9 connector
- LNB Power: 13V or 18V supplied on both LNB-A and LNB-B
- 22 kHz tone: Standard 22 KHz signal superimposed at 0.65V p-p on LNB-A
- DiSEqC: Yes, all 1.0 and 1.1 commands supported
- DiSEqC: Positioner commands for DiSEqC 1.2 and GoToX
- Battery: Rechargeable 12v, 1.8 amp/hour
- Battery Life: About 2 hour on a fully charged battery
- Weight: About 1.5 kg including battery
- Accessories: Nylon carrying case
- Power-supply of 220v/13.8v, 1.5 amp
- Car-charger



Glossary

8PSK: (8 Phase Shift Keying). This is the modulation type that is used for DVB-S2 also called HD. In 8PSK, a symbol has 8 states or 3 bits. On the constellation diagram, an 8PSK signal either be "Normal", with the eight points around a circle centred on the origins or "Rotated" 22.5 degrees.

Attenuator: The attenuator inserts an active resistance into the RF path and reduces the signal level about 3 dB.

BER: (Bit Error Ratio) This is the ratio of $Bits_{Error} / Bits_{Received}$. This is a small number and is usually expressed in scientific notation as $BER = 2 \times 10^{-8}$. Typically, BER should be smaller than 1×10^{-6} for good reception.

dB: (decibel) The decibel is a logarithmic ratio of voltage (or power) to a standard or reference voltage (or power).

$$dB = 20 \log \left(\frac{V}{V_0} \right) \quad \text{or} \quad dB = 10 \log \left(\frac{P}{P_0} \right)$$

DiSEqC: see Appendix D

DVB-S or DVB-S2: see Appendix E

Ext Power: When the Satlook G2 / HD is connected to the power supply and plugged in, then this is displayed on the Analog screen.

FEC: (Forward Error Correction) This is the error control used in DVB and other systems to correct errors in transmission. To do this, the data is sent with additional error correcting bits. On reception, the error bits are identified and (usually) corrected.

HD: (high definition) This refers to any resolution above the DVB standard resolution. The DVB standard resolutions for the luminance signal are (H X V):

720 X 576, 544 X 576, 480 X 576, 352 X 576, 352 X 288

The DVB-S2 High definition resolutions are (H X V) 1920 X 1080 or 1280 X 720. They can either be interlaced or progressive. Interlaced means the picture is built from two "fields" with each field being alternating half the scan lines. Progressive means the entire picture is repeated each time. Progressive pictures require a higher data rate.

IF: (intermediate frequency) This refers to the frequency after down conversion at the LNB to the range 950 MHz to 2150 MHz.

IQ decision points: During demodulation of a QPSK or 8PSK signal, the two phases of the are converted to digital data and this data is sampled at the Symbol Rate. These samples are called IQ decision points (as seen on the constellation diagram) and are then form the digital input symbols.

LNB: (Low Noise Block) The general name for the amplifier and downconverter at the dish.

MaxHold: In the Analog Mode, this can be used to “remember” the highest peak of the RF signal.

MER: (Modulation Error ratio) This is usually expressed in dB. It is calculated from the constellation pattern and represents how close the I and Q decision points are to the ideal position. A typical MER value is 16 dB.

NIT: (Network Information Table) One of the System Information (SI) tables in DVB containing the current satellite name, position, and other data.

QPSK: (Quadrature Phase Shift Keying) This is a digital modulation used for all DVB-S transmissions. The data is transmitted depending on the phase of the signal with 90 degrees the shift, so four states (one symbol) are encoded at each Symbol Frequency.

QPSK HD: DVB-S2 transmissions can be broadcast in either 8PSK modulation or QPSK modulation, When the demodulator receives a DVB-S2 transmission in QPSK, then QPSK HD” is displayed.

RF: (radio frequency) In the Satlook G2 / HD, this is a measurement of the total power in the band from 950 MHz to 2150 MHz.

SIG: (Signal) In the Satlook G2 this is a measurement of the total power in the band from 950 MHz to 2150 MHz. In the Satlook HD, this is a measurement of the RF power at the frequency shown on the display.

SNR: (Signal to Noise Ratio) The SNR of a Signal is a measure of the quality of the signal in dB and higher SNR is better. Typical SNR readings for a clean signal will be greater than 10.0 dB. This is a measurement from the demodulator and is only valid when the received signal is locked.